



APCO | WILLAMETTE

DeZURIK 3-WAY AND 4-WAY PTW/PFW PLUG VALVES



Design & Construction

DeZURIK 3- and 4-Way valves are designed for throttling and diversion of clean, dirty, viscous and corrosive liquids; sludge, abrasive and fibrous slurries; and clean, dirty and corrosive gases.

They feature single and double tapered plug styles, which can be arranged into a variety of flow combinations. Resilient seated plugs are available for dead-tight shutoff with lever and double handwheel actuators only.

All metal plugs are available for high temperature applications but will not provide dead-tight shut off. Single handwheel and powered actuators are available for throttling and diversion applications and do not provide dead-tight shut-off.

DeZURIK 3- and 4-Way valves are ideally suited for refiner bypass and refiner isolation applications. Properly applied, the valves eliminate dead spots and reverse pressure problems typically associated with other valve styles.

Tapered Plug Design

The DeZURIK tapered plug design meets the requirements of all 3- and 4-Way valve applications. Lift, turn, reseal operation combined with resilient plug facings provide dead-tight shutoff on valves with lever or double handwheel actuators. On metal seated and hard rubber lined valves, a clearance between the plug and seat assures smooth and easy valve operation.

Corrosion-Resistant Bearings

Heavy-duty bearings resist corrosion to prevent binding and assure lasting easy valve operation without lubrication. The machined bearings of 316 stainless steel are furnished in the body and bonnet. Hard rubber bearings are furnished in hard rubber lined valves.

Long-Life Stem Seal

The packing and packing gland are accessible without disassembly of the valve. Multiple V-ring packing provides a reliable seal that rarely requires adjustment or replacement, even when the valve is operated continuously. If required, the packing gland permits easy adjustment.

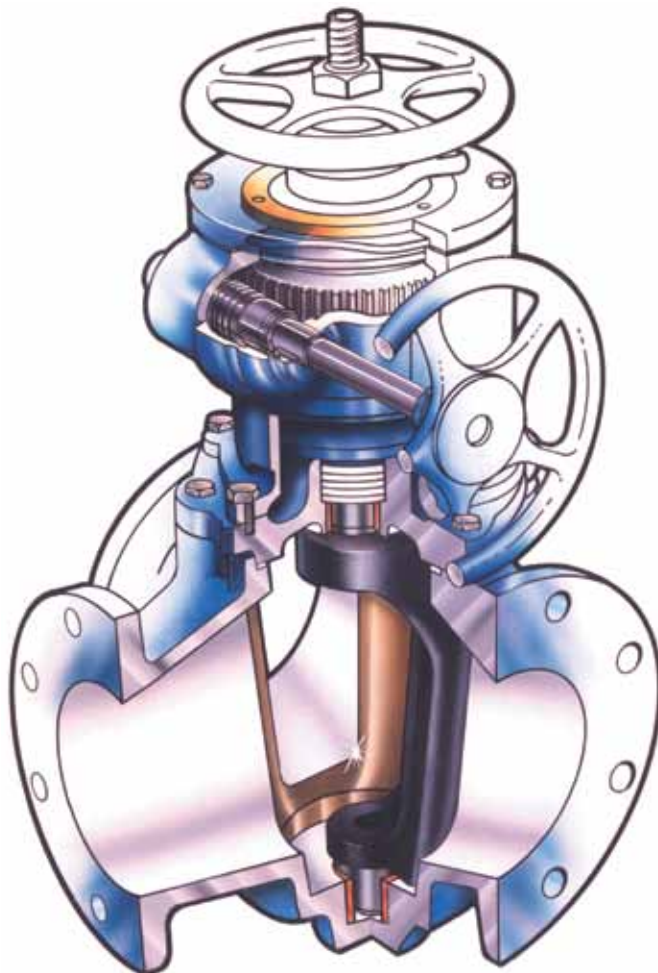

All-Metal Plugs

All-metal plugs are available for high temperature or throttling applications. Metal plugs are furnished in the same material as the valve body, except cast iron valves which feature stainless steel plugs. All-metal plugs can be used with manual and powered actuators where dead-tight shutoff is not required.



Choice of Body Materials

The DeZURIK multiport line offers a variety of materials to meet the requirements of even the most difficult applications. Standard materials include cast iron, aluminum, carbon steel, and 316 stainless steel. Cast iron valves are available with a hard rubber lining on the flange faces and all internal surfaces to provide resistance to chlorine and corrosives. High alloys are available on application.



Resilient Plug Facings

Valves with resilient plug facings provide dead-tight shutoff without the use of sealing lubricants when furnished with lift, turn, reseal levers or handwheel actuators. Even if small solids are trapped between the plug and seat, the resilient facing provides tight shutoff and prevents seat damage. Hard natural rubber plug facings can be furnished with a soft rubber overlay to provide dead-tight shutoff in certain applications.

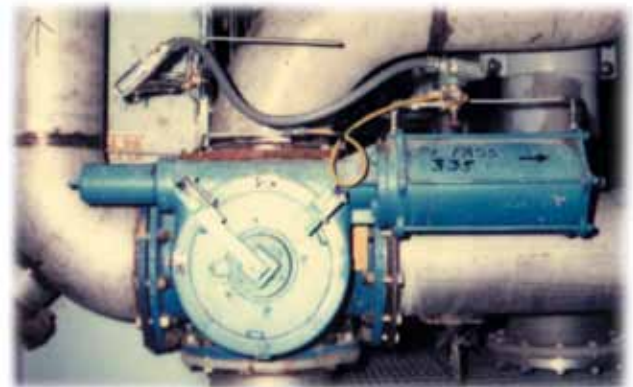

Lift, Turn, Reseat Operation

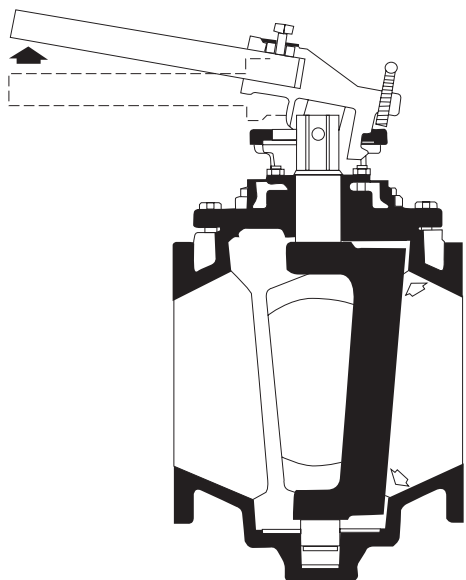

Lift, Turn, Reseat Operation

Lever and double handwheel actuators provide lift, turn and reseal operation. The lever or top handwheel is used to lift the tapered plug away from the seat to provide clearance for easy operation. With the plug unseated, there is no binding or scraping between the plug and seat. At the desired flow position, the plug is reseated.

Wide Line of Actuators

DeZURIK 3- and 4-Way valves are available with levers, single or double handwheels, chainwheels, electric motor, and cylinder actuators. All actuators provide external indication of plug position and flow through the valve.

Flow Combinations

Combination 0

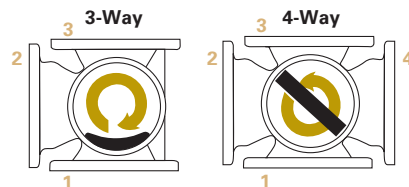

Combination 1

For tight shutoff, it is recommended that the flow be against the back side of the plug.

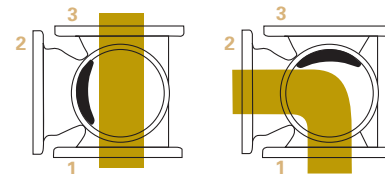

Combination 2

For tight shutoff, it is recommended that the flow be against the back side of the plug.

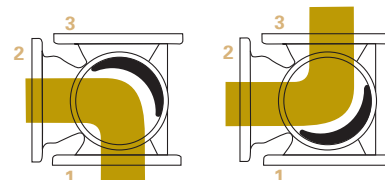

Combination 3

For tight shutoff, it is recommended that the flow be against the back side of the plug.

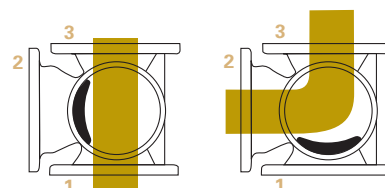

Combination 4

For tight shutoff, it is recommended that the flow be from port flange number 1.

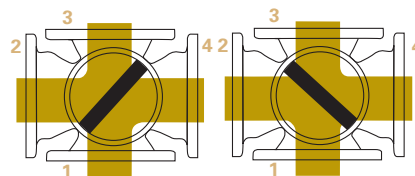

Sales and Service

For information about our worldwide locations, approvals, certifications and local representative:
 Web Site: www.dezurik.com E-Mail: info@dezurik.com



250 Riverside Ave. N. Sartell, Minnesota 56377 • Phone: 320-259-2000 • Fax: 320-259-2227

DeZURIK, Inc. reserves the right to incorporate our latest design and material changes without notice or obligation. Design features, materials of construction and dimensional data, as described in this bulletin, are provided for your information only and should not be relied upon unless confirmed in writing by DeZURIK, Inc. Certified drawings are available upon request.