



APCO AIR VALVE SELECTION & SIZING GUIDE



APCO Air Valves

	Water / Clean Fluids		Sewage / Wastewater	
Air Release Valves	<p>Air Release Valves (ARV)</p>  <p>Body Styles 50A, 200, 200A, 205, 206, 207</p>		<p>Air Release Valve (ASR)</p>  <p>Body Styles 400, 450</p>	
Air / Vacuum Valves	<p>Air / Vacuum Valve (AVV)</p>  <p>Body Styles 140, 140H, 150</p>		<p>Air / Vacuum Valve (ASV)</p>  <p>Body Style 401</p>	
Combination Air Valves	<p>Single Body Combination Air Valves (AVC)</p>  <p>Body Styles 143C, 145C, 149C, 150C, 151C</p>	<p>Single Body Combination Air Valves (ASU)</p>  <p>Body Style CAV, SCAV</p>	<p>Single Body Combination Sewage Air Valve (ASC)</p>  <p>Body Style 440</p>	<p>Single Body Combination Air Valves (ASU)</p>  <p>Body Style SCAV</p>
	<p>Dual Body Combination Air Valves (AVV)</p>  <p>Body Styles 1800, 1800K</p>		<p>Dual Body Combination Air Valve (ASV)</p>  <p>Body Style 401C</p>	

Theory and Use of Air Valves

Air Release Valves and Air/Vacuum Valves are essential components to total pipeline design. Without these essential valves, pipeline capacity will be reduced 5-10% or more due to air pocket build up in the pipeline.

This reduced capacity may go unnoticed because air is an invisible culprit in pipelines. Not only will pockets of air rob precious line capacity, but entrapped air will also rob precious electrical energy. The pump will have to operate at a higher head to overcome the constricted flow. The elimination of air pockets minimizes the problem and greatly improves the pipeline efficiency.

Air Release Valves and Air/Vacuum Valves have a fairly simple construction and are relatively inexpensive. APCO's years of experience have proven almost without exception that the cost of air valves is less than one percent of the total installed pipeline cost.

Air Release Valves represent low cost insurance for protection of expensive pipelines. Furthermore, the Air Release Valves pay for themselves by eliminating air pockets and maximizing the capacity and operating efficiency of the pipeline. Additionally, protection against pipeline damage will also occur because air pockets are a major factor in surge pressures and water hammer in a pipeline.

What are the main types of Air Valves?

There are two main types of air valves:

1. Air Release Valves (typically with small orifice sizes of 1/2" diameter or smaller)
2. Air/Vacuum Valves (typically with large orifice sizes of 1/2" diameter or larger)

When Air Release Valves and Air/Vacuum Valves are combined, they become

3. Combination Air Valves (sometimes called Double Orifice Air Valves)

Where should air valves be installed on pipelines?

Air/Vacuum Valves or Combination Air Valves should be installed on all pipeline high points and changes in grade.

Air Release Valves or Combination Air Valves should be installed on those high points where it is possible for air pockets to accumulate.

Also, Air Release Valves should be installed at intervals of 1,500 to 2,500 feet on long horizontal runs lacking clearly defined high points.

Installing manways at intervals in larger size pipelines provides an excellent point to install Air Release Valves.

What size air valves are required?

Air Valves can be sized by using the graphs and formulas in this bulletin or by using the APCO Air Valve Slide Rule. Contact your local DeZURIK representative for assistance.

To size air valves for a complete pipeline, your local DeZURIK representative can create a complete pipeline profile with recommended valve styles and orifice sizes using our APSLIDE software program. Contact your local DeZURIK representative for details.

Where to install?

Typical pipeline and position of necessary APCO air valves

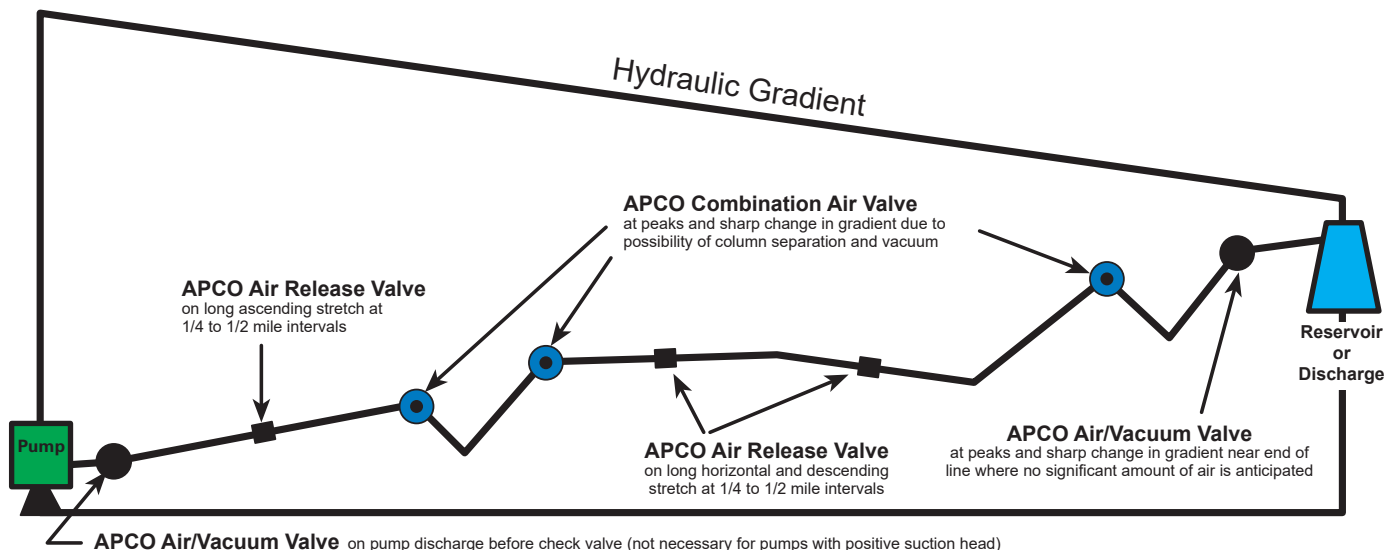

- Air/Vacuum Valve
- Air Release Valve
- Combination Air Valve

Also install on:

1. Centrifugal pumps
2. Hydropneumatic tanks
3. Enclosed systems
4. Sewage lines

When calculating where to install APCO air valves, DeZURIK utilizes formulas found in the latest edition of AWWA Manual of Water Supply Practices M51, titled "Air Release, Air/Vacuum and Combination Air Valves."

Air Release Valves

What Is An Air Release Valve?

Air Release Valves are hydro-mechanical devices which automatically vent small pockets of air that accumulate at high points in a system while the system is operating and pressurized.

Entrained air will settle out of the liquid being pumped and collect at high points in the system. If provisions are not made to remove this air from high points, pockets of air will collect and grow in size. Accumulated air pockets in a system can cause significant problems in pipeline, and Air Release Valves are devices ideally suited to eliminate those problems.

Air pocket growth will then gradually reduce the effective liquid flow area, creating a throttling effect as would a partially closed valve. Often, the velocity of the liquid will remove air bubbles if the pipeline slopes upward. But, if the pipeline is fairly flat, the ceiling of the pipe is very rough or the pipeline slopes downward, the velocity may not be sufficient to keep the air pockets (bubbles) moving.

Air Release Valves must be installed to prevent this 'throttling' effect. In extreme cases it is possible for an enlarging pocket of air collecting at a high point within a system to create an air block to a degree where the flow of fluid virtually stops. In this severe case an entrapped air problem is easily detected and installation of Air Release Valves at the high points will remove the restrictive pockets of air to restore system efficiency.

Another serious consequence is sudden movement of these air pockets causing rapid velocity changes of the liquid being pumped. The dynamics involved in velocity change can be substantial, resulting in high pressure surges and other destructive phenomena in the pipelines.

Problems with air entrapped in a system can range from mild, but costly, to severe and destructive. Accumulation of air pockets can be easily remedied by installing Air Release Valves on all high points of a system.

Air Release Valves for Sewage / Wastewater have an elongated body to minimize the problem of clogging by use of a long float stem which creates an air pocket that prevents sewage from fouling the top mechanism. The potential for air entrapment with sewage pipelines is even greater than in water lines because sewage generates large quantities of gas.



**Compound Lever
APCO ARV Air Release Valve
Body Style 200A**



**Simple Lever
APCO ARV Air Release Valve
Body Style 50A**



Body Style 200



Body Style 205

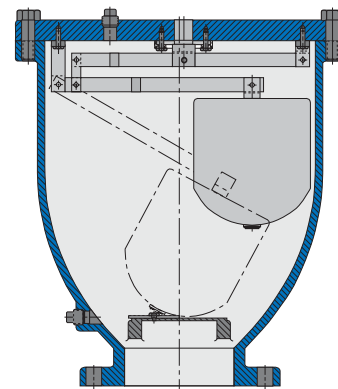

Body Style 207

How Do Air Release Valves Work?

Air Release Valves installed on a high point of the system will fill with liquid, shut off, and be subjected to system pressure. During system operation, small particles of air will separate from the liquid and enter the valve. Each air particle will displace an equal amount of the liquid within the valve and lower the liquid level relative to the float. When the liquid level lowers, the float will drop. This action opens the valve orifice and allows the air which has accumulated in the upper portion of the valve to be released to atmosphere. As air is released, the liquid level within the valve rises again, lifting the float and closing the valve orifice. This cycle repeats itself as often as air accumulates in the valve.

Air Release Valves use of a leverage mechanism to open and release accumulated air under pressure. When the float is no longer buoyant, this mechanism (plus the weight of the float) produces a greater force to open the valve than to hold the valve closed.

Accordingly, the higher the system pressure the smaller the orifice diameter must be to allow the valve to open and release accumulated air. Conversely, with the same valve and a lower system pressure, a larger diameter orifice can be used to release accumulated air.

Air Release Valves are not normally recommended for vacuum protection nor to vent large volumes of air when filling large diameter pipelines because they have small orifices, usually less than 1/2" diameter. Air/Vacuum Valves have much larger orifices for this purpose. However, Air Release Valves will permit small quantities of air to re-enter under negative conditions. To prevent air re-entry, an Air Release Valve with a vacuum check may be specified.



**APCO ASR Sewage
Air Release Valve
Body Style 400, 450**

Sizing Air Release Valves

Air Release Valves discharge air (which has accumulated inside the valve) from high point in the pipeline. Generally, Air Release Valves are not constantly discharging air during system operation, but only discharge intermittently as air accumulates.

Air entrapped in pipelines is an invisible culprit and it can be difficult to quantitatively measure the precise amount of entrapped air in a flooded transmission pipeline. Variables such as the source of media, pressure differential across the pump, operating pressure, and pressure/ temperature fluctuations along the transmission line will affect the amount of air released from the media. However, the volume of liberated air (from the media) which accumulates and must be vented from each high point can be calculated as follows:

Air Valve Sizing

1. Use 2% of the media volume divided by the number of high points as the minimum amount of entrapped air.
2. Consider this volume as the basis for the amount of air to be discharged from each high point.
Amount of air to be discharged CFM = Flow Capacity in $\frac{\text{GPM} \times 2\%}{7.48}$
or $\frac{\text{Flow Capacity in GPM}}{374}$

3. Upon determining the operating pressure of the system, refer to the Venting Capacity Graph for Air Release Valves to determine the orifice size needed. Then refer to the Table of Orifice Sizes to select valve style with that orifice size.

Example:

1. A pipeline actual flow capacity of 18,700 GPM and operating at 150 psi.
Amount of air to be discharged = $\frac{18,700}{374} = 50$ CFM
2. Using the Venting Capacity Graph for Air Release Valves 50 CFM and 150 psi will intersect the 3/16" orifice curve.
3. On the Table of Orifice Sizes, Body Style 200A with 3/16" orifice can be selected with the appropriate inlet size.

Sizing an Air Release Valve when a Specific venting capacity is required

1. On the Venting Capacity Graph for Air Release Valves, find the system pressure on the Y axis and the venting capacity required on the X axis.
2. Find the orifice diameter closest to the intersection of pressure and capacity lines on graph.
3. Refer to the Table of Orifice Sizes to select valve style with that orifice size.

Venting Capacity Graph for Air Release Valves

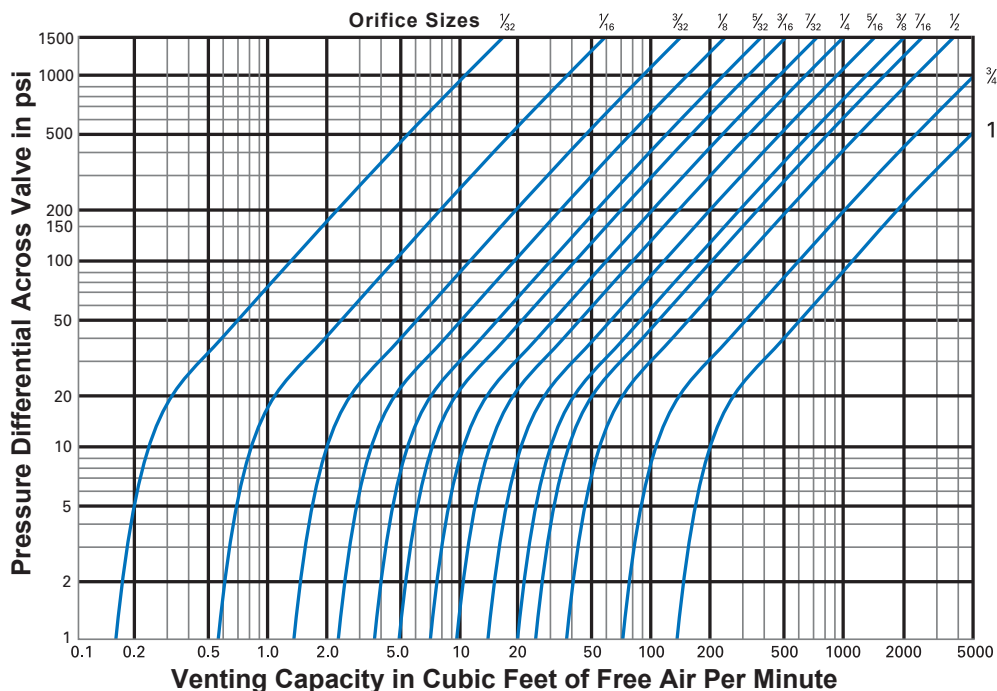

Note: If the intersection of the Venting Capacity (CFM) and Operating Pressure (psi) lies between two orifice curves, use the larger orifice.

Table of Orifice Sizes for Air Release Valves

Valve Type	Body Style	End Connection Order Code	Body Material	Valve Size	Orifice Order Code	Orifice Diameter	Valve Minimum Rated Pressure (psi)	Valve Maximum Rated Pressure (psi)	Venting Capacity (CFFAM)	
ARV	50A	T1	DI	.5-1"	R332	3/32"	8	175	18	
					R116	1/16"	11	300	12	
	200A	T1 & F1N	DI	1-2"	L516	5/16"	3	15	25	
					R516	5/16"	11	50	65	
					R14	1/4"	11	75	65	
					R316	3/16"	11	150	60	
		T1	DI	1-2"	R532	5/32"	11	300	75	
					M332	3/32"	11	600	55	
		F1N	DI*	1-2"	R532	5/32"	11	250*	65	
					M332	3/32"	11	250*	25	
	200	T1, F1N, & F2N	DI	2-3"	L12	1/2"	3	15	60	
					R12	1/2"	11	75	225	
					R38	3/8"	51	150	250	
					M732	7/32"	51	300	150	
	T1	DI	2-3"	2-3"	M732	7/32"	51	250*	130	
					F2N	DI	2-3"	M732	7/32"	51
	205	T1	DI	2"	H12	1/2"	50	100	300	
					H38	3/8"	50	150	250	
					H732	7/32"	50	500	250	
					H18	1/8"	50	800	125	
	206	T1	CS	2"	H332	3/32"	50	1500	150	
		F4N			H332	3/32"	50	985	75	
		F6N			H332	3/32"	50	1480	140	
	207	F1	DI*	6"	L1	1"	3	15	235	
					R1	1"	11	150	1700	
					R75	3/4"	11	250*	1250	
	ASR	400	T1 & F1N	DI	2-4"	L516	5/16"	3	15	25
						R516	5/16"	11	50	65
R14						1/4"	11	75	65	
R316						3/16"	11	150	60	
R532						5/32"	11	300	75	
R532						5/32"	11	250*	65	
450		T1 & F1N	DI	2-4"	L12	1/2"	3	15	60	
					R12	1/2"	11	75	225	
					H12	1/2"	51	150	450	
					R716	7/16"	76	300	550	
F1N	DI*	2-4"	2-4"	R716	7/16"	76	250*	450		
ASU	CAV	T1	S2	1-4"	H516	5/16"	-	300	300	
		F1	S2*	2-4"	H516	5/16"	-	275*	275	
	SCAV	T1	S2	1-4"	R516	5/16"	-	150	175	
		F1	S2*	1-6"	R516	5/16"	-	275*	275	

Pressure Ratings are at ambient temperature. Limiting factor for Working Pressure is the lowest pressure rating of the end connection, valve rated pressure and orifice pressure rating.

*Valve maximum rated pressure at ambient temperature with a flanged inlet for Carbon Steel Valves is 285 psi; stainless steel valves is 275 psi.

Air/Vacuum Valves

What Are Air/Vacuum Valves?

Air/Vacuum Valves allow large volumes of air to be exhausted from or admitted into a system as it is filled or drained. Air/Vacuum Valves are float operated and have a large discharge orifice, equal in size to the valve inlet.

Prior to filling, a pipeline is filled with air. This air must be exhausted in a smooth uniform manner to prevent pressure surges and other destructive phenomenon from occurring in the pipeline. Conversely, air must also be allowed to re-enter the pipeline in response to a negative pressure in order to prevent a potentially destructive vacuum from forming. Even when vacuum protection is not a primary concern, air re-entry is still essential to efficiently drain the pipeline.

At locations where column separation is anticipated an Air/Vacuum Valve will allow air to enter, preventing a destructive vacuum from forming which is as damaging as pressure surges.

Air/Vacuum Valve Operation

As the pipeline is filled, air is exhausted to atmosphere through an Air/Vacuum Valve mounted on each high point. As air is exhausted, water will enter the valve and lift the float to close the valve orifice. The rate of air exhausted is a function of pressure differential, which develops across the valve discharge orifice. This pressure differential develops as water filling the pipeline compresses the air sufficiently to give it an escape velocity equal to that of the incoming fluid. Since the size of the valve controls the pressure differential at which air is exhausted, valve size selection is an important consideration.

During system operation, the internal pressure of the pipeline can approach a negative value due to events such as column separation, draining of the pipeline, power outage or pipeline break. This will cause the float to immediately drop away from the orifice and allow air to re-enter the pipeline. Air re-entry during water column separation will prevent a vacuum and protect the pipeline from collapse. The Air/Vacuum Valve, having opened to admit air into the pipeline in response to a negative pressure, is now ready to exhaust air again. This cycle will repeat as often as necessary.

During system operation and while under pressure, small amounts of air will enter the Air/Vacuum Valve from the pipeline and displace the fluid. Eventually, the entire Air/Vacuum Valve may fill with air, but it will not open because the system pressure continues to hold the float closed against the valve seat. An Air/Vacuum Valve's purpose is only to exhaust air during pipeline fill and to admit air during pipeline drain. An Air Release Valve is required to release accumulated air pockets during system operation.



**APCO AVV
Air/Vacuum Valve
Body Style 150, 4-18"**



**APCO AVV
Air/Vacuum Valve
Body Style 140, .5-3"**

Characteristics of Air Flow Through an Air/Vacuum Valve Orifice

The linear velocity of air discharged through the orifice of an Air/Vacuum Valve increases as pressure differential across the orifice increases, until reaching a maximum velocity of approximately 300 feet per second. This maximum air velocity occurs at about 7 psi and remains a constant thereafter, regardless of further increase in the pressure.

Unlike liquids, the volume of air that fills one cubic foot at atmospheric pressure will occupy a progressively lesser volume as its pressure increases.

The amount of air actually expelled through the orifice continues to increase indefinitely as the pressure increases. While there is no further increase in the escape velocity beyond approximately 7 psi, the air escaping at this velocity becomes progressively denser and represents a greater amount when expressed in cubic feet at atmosphere. To accommodate this condition, flow of air is always referred to in Cubic Feet of Free Air per Minute (CFFAM) even though the air under consideration is usually at some other pressure than atmosphere.



**APCO ASV
Sewage Air/Vacuum Valve
Body Style 401**

Sizing Air/Vacuum Valves

APCO Air/Vacuum Valves open whenever the internal pressure of the pipeline approaches a negative value, allowing the water level in the valve to lower and the float to drop from the seat. The function is to vent large volumes of air from pipelines when they are initially filled and to allow air to re-enter the lines to break a vacuum.

On a typical pipeline profile, the gradients indicated can be used for pipeline slopes for calculating the flow down the pipeline. A minimum valve size is established by finding the size for filling, which is usually less than the drainage flow. A 2 psi pressure differential is typically used for the filling flow; 5 psi for the drainage flow. Above 2 psi, the air flow out across the valve orifice becomes so great, it may cause two problems: First, the valve may close prematurely due to turbulence, trapping an air pocket in the system. Secondly, when the valve closes, the abrupt cessation of flow may create substantial pressure rise and slam, which may damage the air valve or pipeline. The 5 psi differential for inflowing air represents a safe average for protecting the pipeline and gasketed joints from damage due to vacuum.

Air/Vacuum Valve Sizing

1. Calculate necessary valves independently for each high point line.
2. Consider the more severe of the two gradients adjacent to each high point.
3. Determine the maximum rate of flow in cubic feet per second which can occur in this gradient for both filling and draining of the line. Always be sure to take the highest possible rate of flow under either circumstance (filling or draining).

To calculate rate of flow:

If the line is being filled by pump:

$$\text{Rate of flow in CFS} = \frac{\text{GPM of pump}}{449}$$

If the line is being drained by gravity:

$$\text{Rate of flow in CFS} = 0.08666 (SD^5)^{1/2}$$

Where S = Slope (in feet per foot of length)

D = Diameter of pipe (inches)

4. The valve to be installed at this high point must release or re-enter an amount of air in cfs equal to the maximum possible flow of water in CFS immediately adjacent to this now determined high point.

5. To economize on the size of valves selected, the final step is to determine the maximum pressure differential which can be tolerated across the valve orifice consistent with the required flow of air in CFS already determined.
6. To determine the maximum tolerable differential pressure, if there is a risk of line collapse from vacuum. This condition is usually only present in thin-walled steel lines above 24". To calculate collapsing pressure for thin-walled, cylindrical pipe.

$$P = 12500000 \left(\frac{T^3}{D} \right)$$

Where P = Collapsing pressure (psi)

T = Thickness of pipe (inches)

D = diameter of pipe (inches)

Includes Safety Factor of 4

Inflow

7. For draining and air inflow, use the maximum pressure differential calculated, or 5 psi, whichever is lower. Follow the line for this differential (never greater than 5 psi) and the flow found during draining to find the appropriate valve size that will protect the line from collapse and water column separation due to vacuum.

Outflow

8. For filling and air outflow, use the maximum rate at which the line can be filled, and use a 2 psi differential pressure. This valve size is sufficient to vent all air from the line before valve closure. This ensures maximum performance from the line.
9. Compare the valve sizes determined in steps 7 & 8, and use whichever size is larger for total protection of the system.
10. These valves should be installed on the high point with a shut-off valve below them.
11. The same procedure should be followed for each individual high point.
12. If the pipeline lacks clearly defined high points, or if the high points are separated by long stretches of uniform gradient, it is recommended that the proper valves be selected as explained above and duplicate installations be made at regular intervals of 1/4 to 1/2 mile increments.

Performance Graphs for Air/Vacuum Valves

Inflow

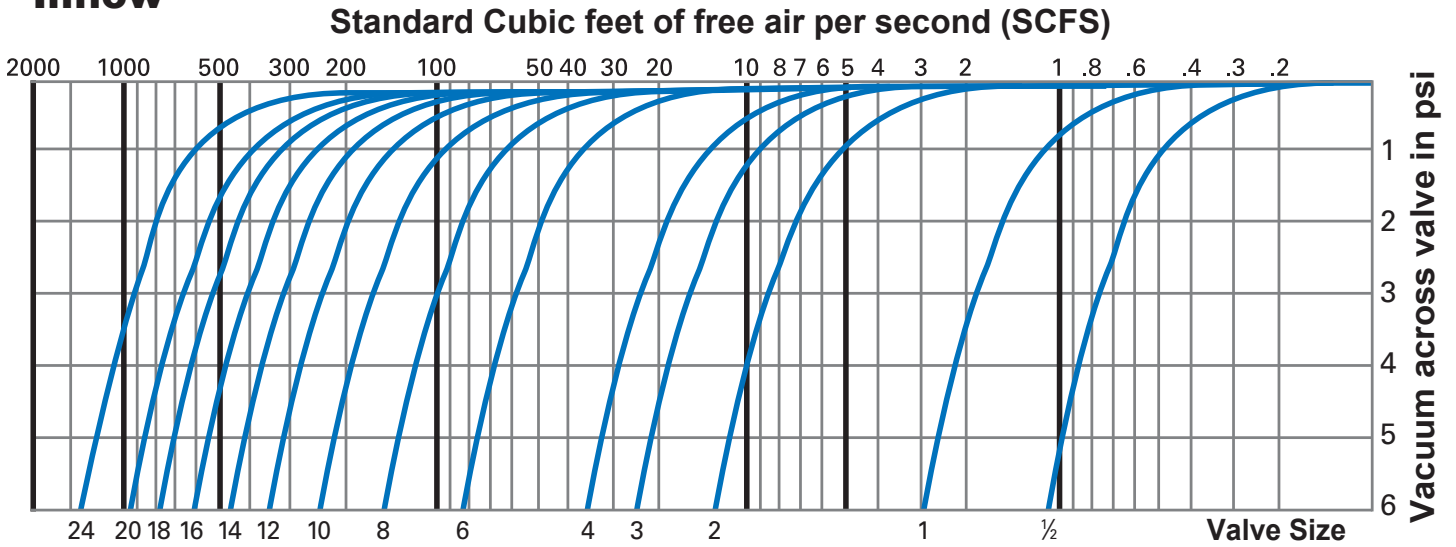

Outflow

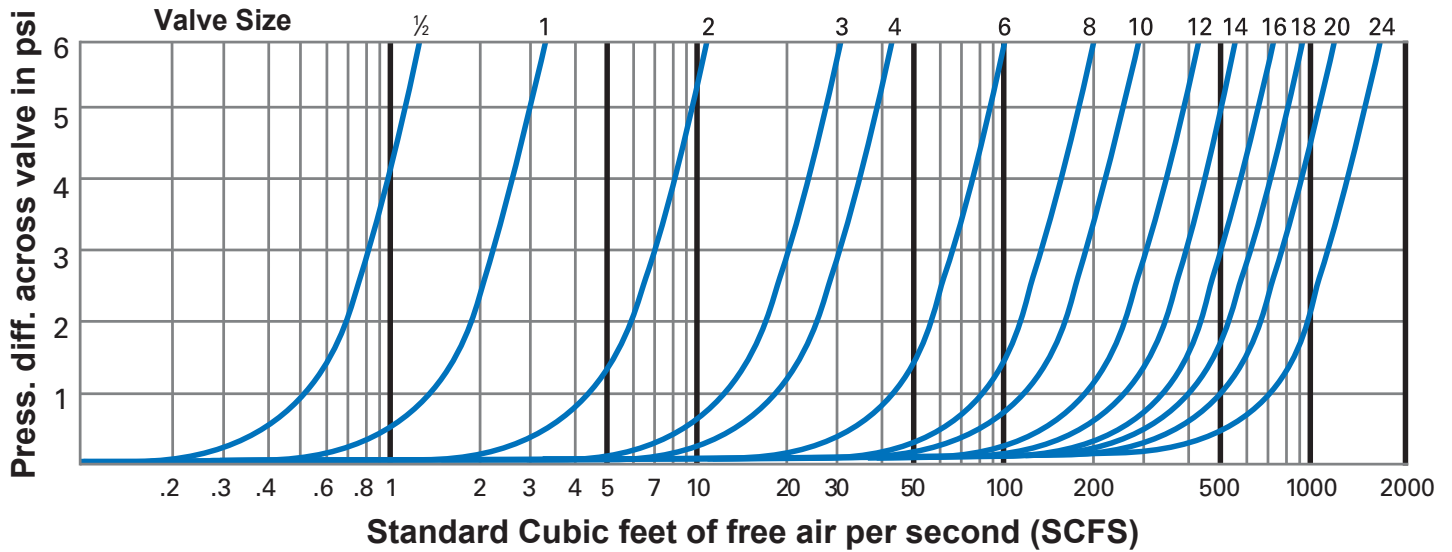

Combination Air Valves

What Are Combination Air Valves?

Combination Air Valves have operating features of both Air Release Valves and Air/Vacuum Valves. Combination Air Valves are installed on all high points of a system where it has been determined Air/Vacuum and Air Release Valves are needed to vent and protect a pipeline. Generally, it is sound engineering practice to use Combination Air Valves instead of single purpose Air/Vacuum Valves.

Combination Air Valves are available in two body styles:

1. Single Body Combination Air Valves

The Single Body Combination Air Valve is used where compactness is preferred and/or where risk of tampering exists due to accessibility of the installation.

2. Dual Body Combination Air Valves

Dual Body Combination Air Valves are an Air/Vacuum Valve piped with a shut-off valve to an Air Release Valve. Dual Body Combination Air Valves can have greater versatility than the single body style because a variety of Air Release Valves with a wide range of orifices and higher operating pressures can be used.

For pipeline economy and operating efficiency, pipelines should be laid to grade where possible, rather than merely following the natural terrain. The result will be smoother less turbulent flows of liquid, fewer high points where air will collect, so fewer air valves are needed.

How Do Combination Air Valves Work?

Combination Air Valves exhaust large volumes of air as the system is filled and prevent the accumulation of air at high points within a system by releasing accumulated pockets of air while the system is operational and under pressure. Combination Air Valves prevent potentially destructive vacuums from forming during power outages, water column separation or sudden rupture of the pipeline. Additionally, these valves allow the system to be easily drained because air will re-enter, as needed.

Potentially damaging vacuum conditions and pressure surges induced by air can be avoided and maximum pipeline efficiencies attained through proper understanding and application of air valves.



APCO AVC Single Body Combination Air Valve



APCO ASU Single Body Combination Air Valve Body Style CAV, SCAV



APCO AVV Dual Body Combination Air Valve Body Style 1800, 1800K

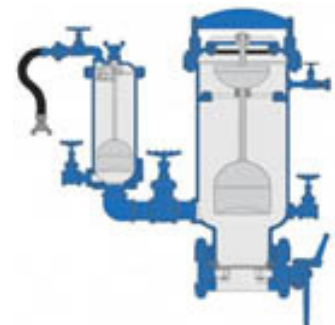

APCO ASV Dual Body Sewage Combination Air Valve Body Style 401C

Options

Slow Closing Valves

What is a Slow Closing Air Valve?

The APCO Slow Closing Air Valve (CSV) is a standard Air/Vacuum Valve mounted on top of a Surge Check Unit. The Slow Closing Air Valve is designed to eliminate critical shock conditions on installations where operating conditions cause a regular air valve to slam shut.

How Does a Slow Closing Valve Work?

The Air/Vacuum Valve operates in the normal fashion allowing air to escape freely. The Surge Check Unit operates on the interphase between the kinetic energy in the relative velocity flow of air and water.

Air passes through unrestricted but when water rushes into the Surge Check Unit, the disc closes and reduces the rate of water flow into the air valve by means of throttling holes in the disc. This ensures normal gentle closing of the Air/Vacuum Valve regardless of the initial velocity flow involved. This also minimizes pressure surges when the valve closes.

As soon as the air valve is closed, the pressure on both sides of the Surge Check Unit disc equalizes and the disc automatically returns to its open position. This means the air valve surge check does not need an incipient vacuum to open, but can open at any time the water level drops and line pressure approaches atmospheric level. This immediately allows the full re-entry flow of air into the pipe line.

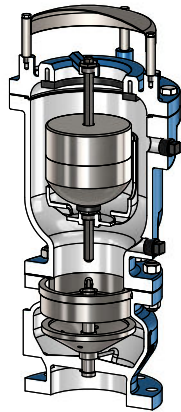

Slow Closing Air/Vacuum Valve, AVV Body Style 150 with CSV Surge Check Valve

Refer to bulletin 613 for details.

Vacuum Relief/Air Inlet Valves

What Are Vacuum Relief/Air Inlet Valves?

Vacuum Relief/Air Inlet Valves (AVR) are large orifice one-way valves. They permit air to enter the pipeline or system (to break the vacuum), but no air escapes when the system pressure returns to positive.

Vacuum Relief/Air inlet Valves are normally closed spring-loaded valves that respond to a vacuum in the pipeline. The Vacuum Relief/Air Inlet Valve is designed to open with a minimal 1/4 psi pressure differential across the orifice. Higher or lower settings are available.

Vacuum Relief/Air inlet Valves are available in combination with APCO Air Release Valves to permit full flow air into the pipeline and slow air out of the pipeline through the Air Release Valve orifice.

Refer to bulletin 1500 for details.



APCO AVR Vacuum Relief/ Air Inlet valves

Air Valves for Vertical Turbine Pumps

Air Valves for Vertical Turbine Pumps are essential to prevent large volumes of air from entering the water system each time the pump is started and to break a vacuum when the pump stops. Air Valves for Vertical Turbine Pumps are basically Air/Vacuum Valves with additional options and accessories such as an internal Water Diffuser (WD) or an external Double Acting Throttling Device (DAT) or inlet water Surge Check Valve (CSV).



**AVV Air/Vacuum Valve with
Surge Check (CSV)**

These options and accessories are essential to suit these valves for use on Vertical Turbine deep well pumps. Without these features, a basic Air/Vacuum Valve will most likely spill substantial amounts of water before shutting off, or it may not shut off at all. These features will prevent premature closure due to the air in the suction column being saturated with moisture.

Refer to bulletin
586 for details



**AVV Air/Vacuum Valve with
Double Acting Throttling
Device (DAT)**

Sales and Service

For information about our worldwide locations, approvals, certifications and local representative:

Web Site: DeZURIK.com E-Mail: info@DeZURIK.com



250 Riverside Ave. N. Sartell, Minnesota 56377 • Phone: 320-259-2000 • Fax: 320-259-2227

DeZURIK, Inc. reserves the right to incorporate our latest design and material changes without notice or obligation. Design features, materials of construction and dimensional data, as described in this bulletin, are provided for your information only and should not be relied upon unless confirmed in writing by DeZURIK, Inc. Certified drawings are available upon request.